

# Operating Instructions

## Testomat<sup>®</sup> 808 SiO<sub>2</sub> 2019

Online Analysis Instrument  
for silica up to 1.2 mg/l



# Content

<b>Content</b> .....	<b>2</b>
<b>Important safety information</b> .....	<b>4</b>
Intended use .....	4
Qualification of the staff .....	4
Warning notices in these instructions .....	5
<b>Notes and instructions to be observed</b> .....	<b>5</b>
General instructions .....	5
Installation .....	6
Operation .....	6
Cleaning .....	6
De-installation .....	6
Disposal .....	6
Operating requirements .....	7
Shelf life of reagents .....	7
<b>Scope of delivery</b> .....	<b>8</b>
<b>Performance specifications</b> .....	<b>8</b>
<b>Functions of the operating and display elements</b> .....	<b>9</b>
Switching Testomat® 808 SiO <sub>2</sub> on/off .....	9
Front view Testomat® 808 SiO <sub>2</sub> .....	9
Operating elements/Function keys .....	10
Display elements/LEDs .....	11
<b>Installation</b> .....	<b>12</b>
Installing attachable shell .....	12
Installing Testomat® 808 SiO <sub>2</sub> .....	13
Operating Testomat® 808 in the pressure range 4 to 8 bar .....	13
Connecting the water inlet and outlet .....	14
Water inlet .....	14
Water outlet .....	14
Connecting the power supply and devices .....	15
Connecting the mains voltage .....	16
Connecting the inputs and outputs .....	17
Examples of a hospital sterilisation system .....	18
Diagram of a silicate measurement with Testomat® 808 SiO <sub>2</sub> .....	19
<b>Internal design Testomat® 808 SiO<sub>2</sub></b> .....	<b>20</b>
Rear of the controller board .....	20
Reset key S1 .....	20
Function key S6 (interval pause) .....	20
Function key S7 (Measuring / monitoring area) .....	21
Slide switch T1 .....	21
Slide switch T2 .....	22
Plug connector J1 .....	22
Plug connector J2 .....	22
Plug connector J3 .....	22
Base circuit board Testomat® 808 SiO <sub>2</sub> .....	23
Plug connector J2 .....	23
Current interface .....	23
Inputs DEL. EXT. and STOP .....	23
Terminal block .....	24
Fuses .....	24

<b>Description of the signal inputs .....</b>	<b>25</b>
<b>Interfaces .....</b>	<b>25</b>
Current interface .....	25
Serial interface RS232 .....	26
<b>Description of the relay outputs.....</b>	<b>26</b>
Relay 3 – fault message .....	26
Relays 1 and 2 .....	27
<b>Commissioning .....</b>	<b>28</b>
Inserting the reagent bottles .....	28
Bleeding the lines.....	29
Opening the water inlet .....	29
<b>Instrument settings and analysis.....</b>	<b>30</b>
Instrument settings.....	30
Selecting the indicator type and bottle size .....	31
Carrying out an analysis .....	31
Analysis process .....	32
<b>Further basic functions and settings.....</b>	<b>33</b>
Internal flushing.....	33
Flush process – manual mode.....	33
Interval pause .....	34
72 h operation (operation without permanent supervision) .....	35
<b>Error messages/Troubleshooting .....</b>	<b>36</b>
Alarm/Error message/Relay 3.....	36
Low water level .....	38
Measuring fault analysis .....	39
Defective pump motor .....	39
Further possible instrument errors .....	39
<b>Maintenance .....</b>	<b>41</b>
Service instructions .....	41
Description of maintenance work.....	42
Replacing the reagent bottles .....	42
Cleaning the measuring chamber and the sight-glass windows.....	43
Pump head maintenance message .....	45
Motor block maintenance.....	45
<b>Testomat® 808 SiO2 2019 spare parts and accessories.....</b>	<b>46</b>
Accessories - reagents .....	47
<b>Technical data .....</b>	<b>48</b>
<b>Testomat® 808 SiO2 2019 checklist.....</b>	<b>49</b>
<b>EC conformity Declaration.....</b>	<b>51</b>



## Important safety information

- Please read these operating instructions carefully and completely prior to working with the instrument.
- Ensure that these operating instructions are always available for all users.
- These operating instructions must always be passed on to the new owner should Testomat® 808 SiO<sub>2</sub> change hands.
- Always adhere to hazard warnings and safety information when using reagents, chemicals and cleaning agents. Please adhere to the respective safety data sheet! Download the safety data sheets for the supplied reagents at <http://www.heylanalysis.de>.

## Intended use

The Testomat® 808 SiO<sub>2</sub> equipment has been designed for use in the sterilisation of hospitals. It complies with the EN 285:2006 standard. The device is a limit gauge that automatically monitors the level of SiO<sub>2</sub> in the water. You have a choice between 10 limits in the range of 0.3 to 1.2 ppm. It can, however, be used only for molybdenum-reactive silicate, as the limit value is determined using molybdenum-enriched reagents.

- Always adhere to the performance limits stated in the section entitled [Technical data](#) on page 48.
- Always observe the application areas/application limits of the indicators and the requirements of the medium being measured.

To ensure correct and intended usage, always read and understand these instructions, especially the section entitled “Important safety information”, prior to use.

The instrument is not used as intended if

- it is used in areas not specified in these instructions.
- it is used in areas which do not correspond to the ones described in these instructions.

## Qualification of the staff

Assembly and commissioning require fundamental electrical and process engineering knowledge as well as knowledge of the respective technical terms. Assembly and commissioning should therefore only be carried out by a specialist or by an authorised individual supervised by a specialist.

A specialist is someone who due to his/her technical training, know-how and experience as well as knowledge of relevant regulations can assess assigned tasks, recognise potential hazards and ensure appropriate safety measures. A specialist should always adhere to the relevant technical regulations.

## Warning notices in these instructions

The warning notices in these instructions warn the user about potential dangers to individuals and property resulting from incorrect handling of the instrument. The warning notices are structured as follows:



---

### Description of the type or source of danger

Description of the consequences resulting from non-observance

- Preventive measures. Always adhere to these preventive measures.



“**DANGER**” indicates an immediate hazardous situation which, if not avoided, will result in death or serious injury.



“**WARNING**” indicates a potentially hazardous situation which, if not avoided, could result in death or serious injury.



“**CAUTION**” indicates a potentially hazardous situation which, if not avoided, could result in minor or moderate injuries or property damage.



“**NOTE**” indicates important information. If this information is not observed, it may result in an undesirable result or state.

## Notes and instructions to be observed

### General instructions



- Adhere to health and safety regulations, electrical equipment safety regulations, and environmental protection regulations valid in the country of use and at the installation site.
- Adhere to national and local regulations during installation and commissioning.
- Always protect the instrument against moisture and humidity. It should never come into contact with condensation or splash water.
- Do not carry out any changes or modifications at the instrument which are not described in these instructions; failure to adhere to these instructions will negatively affect any warranty claims that you make thereafter.



## Installation

- Always completely disconnect the relevant plant part before installing the instrument or connecting/disconnecting it to/from the power supply. Secure the plant against reconnection.
- Only connect the instrument to the mains voltage specified on the rating plate.
- Always observe technical data and ambient parameters.
- Testomat® 808 SiO<sub>2</sub> requires an interference free and stable power supply. If necessary, use a mains filter to protect Testomat® against interference voltages caused, e.g., by solenoid valves or large motors. Never lay connecting cables parallel to power cables.

## Operation

- Ensure that the maximum electrical load capacity of the relay outputs is never exceeded.
- Immediately switch off Testomat® 808 SiO<sub>2</sub> and contact service staff if malfunctioning occurs. The warranty will be void if you tamper with or attempt to repair Testomat® 808 SiO<sub>2</sub>. Repairs must be carried out by authorised service staff.

## Cleaning

- Only use a dry, lint-free cloth for cleaning.

## De-installation

- Prior to de-installing a defective instrument, always write down a description of the error (failure effect). It is only possible to repair a defective instrument (irrespective of the warranty period) if it has been de-installed and returned to us with a description of the error. Use the enclosed error log to describe the error and return it to us together with the instrument. If the error log is no longer available, download it at [www.heylanalysis.de](http://www.heylanalysis.de).

## Disposal

- Dispose of the instrument in accordance with national regulations.

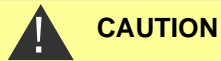
**CAUTION****NOTE**

## Operating requirements

- In order for Testomat® 808 SiO<sub>2</sub> to operate reliably, use Heyl Testomat® indicators in the pH-range 4 – 10.5!
- Only operate the instrument with the parameters specified under “Technical data”.
- The device can only be used for molybdenum-reactive silicate, as the limit value is determined using molybdenum-enriched reagents.
- The concentration of influencing contents can be determined by using our colorimetric TESTOVAL® test kit
- Careful handling of the instrument increases both its operational reliability and service life! Therefore, carry out a visual inspection at regular intervals as described below:
  - Has the use-by-date of the reagents expired?
  - Are the hose connections of the dosing pump free of leaks?
  - Is there any air inside the dosing hoses?
  - Are all the water connections free of leaks?
  - Are the doors of the instrument closed properly?
  - Is the instrument heavily soiled?
  - Are the measuring chamber and the drain duct/drain hose clean?
- Trouble-free operation is only possible when maintenance is carried out on a regular basis! For more information, please refer to the section entitled Maintenance on page 41.
- If problems occur, please refer to the section entitled “[Error messages/Troubleshooting](#)” on page 36.

## Shelf life of reagents

Please note that the specified one-year shelf life of the reagents applies only to unopened bottles. If the bottle has been opened, however, the shelf life is significantly reduced, as some substances therein are volatile. Use the indicator within six months of opening the bottle or install a new bottle to continue to maintain a satisfactory measurement result.

## Scope of delivery

1x Testomat® 808 SiO<sub>2</sub> 2019

2x screw caps with a hole and insert for the screw cap of the indicator bottle (500 ml)

1x extension hose with hose nipple

1x operating instructions

1x candle filter

1x attachable shell for 500 ml bottle

2x screws

Special accessories (available separately): pressure regulator

Required hose connections and supply lines for Testomat® 808 SiO<sub>2</sub> are available from Heyl.

## Performance specifications

The Testomat® 808 SiO<sub>2</sub> automatically monitors the SiO<sub>2</sub> silicate content in water. It is a limit gauge that uses LEDs to indicate whether the sample is below the set limit (green) or above it (red) after the analysis.

- Using the S7 function switch, 10 points can be set from 0.3 to 1.2 ppm SiO<sub>2</sub> (page 21).
- Analysis start:
  - Automatic interval mode  
(with S8 the interval pause can be set from 0 – 480 minutes)
  - External control
  - Manual start
- Extended operating periods due to 500 ml indicator storage bottle
- RS232 interface for optional firmware update and data output to the computer
- Weekend operation monitoring through 72-hour operation without supervision (BOB)
- Status and error messages output via a current loop



## Functions of the operating and display elements

Operating statuses and measuring results are displayed at Testomat® 808 SiO<sub>2</sub> via LEDs. The input keys for operating the instrument are positioned below the LEDs.

### Switching Testomat® 808 SiO<sub>2</sub> on/off



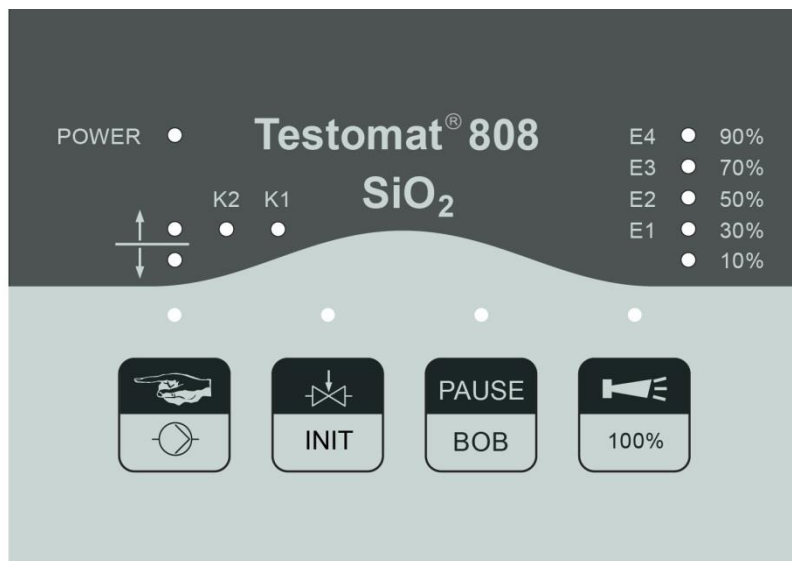

- (1) External power switch  
Switch the device on or off at the external power switch.
- (2) Instrument fuse (internal)  
These fuses protect Testomat® 808 SiO<sub>2</sub> and the outputs against overloads and short circuits.  
Please refer to the sections entitled “[Fuses](#)” on page 24 and “[Error messages/Troubleshooting](#)” on page 36 for descriptions of the fuses.

### Front view Testomat® 808 SiO<sub>2</sub>



## Operating elements/Function keys

All operating elements/function keys are assigned twice. The respective function is triggered by a short or long (min. 2 seconds) key press.



<p>Key 1 (manual)</p> 	<p><u>Short key press:</u> Starts an analysis (manual start), the respective LED flashes.</p> <p><u>Long key press:</u> Switches the dosing pump for bleeding the pipes on/off. The LED illuminates while the pump is running.</p>
<p>Key 2 (flushing)</p> 	<p><u>Short key press*:</u> Switches the internal flush valve on/off, the respective LED flashes as long as the valve is open.</p> <p><u>Long key press*:</u> Resets relay 1 and/or 2 when pulled. Deleting Filter 1 exhausted and/or Filter 2 exhausted messages.</p>
<p>Key 3 (pause)</p> 	<p><u>Short key press:</u> Switches the standby function on/off. The respective LED flashes if standby is active.</p> <p><u>Long key press:</u> The respective LED displays whether operation is possible for longer than 72 h (operation without supervision) and whether the indicator amount is sufficient at the set interval pause for the next 72 hours.</p>
<p>Key 4 (horn)</p> 	<p><u>Short key press:</u> Acknowledges current errors/alarms.</p> <p><u>Long key press:</u> Sets the indicator display from 0% to 100% (the LEDs 10% to 90% illuminate).</p> <p><b>Note:</b> It is not possible to enter any indicator level.</p>

\* only in standby mode

## Display elements/LEDs

All measuring results as well as activated functions are displayed at Testomat® 808 SiO2 via LEDs.

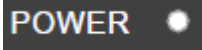
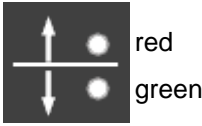
The LEDs above the function keys illuminate/flash when the respective function is activated.

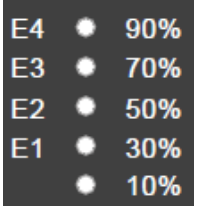
	<p>The LED lights up when the device is supplied with power and is in operation.</p>
	<p>Limit value LEDs (red/green) for displaying the measuring result:                      Limit value not achieved =&gt; green LED illuminates                      Limit value exceeded =&gt; red LED illuminates                      When a new measuring is running, the result of the previous measurement flashes.</p>
	<p>The LEDs K1 and K2 display the status of the relays. They illuminate if the respective relay has been switched (also see the section entitled <a href="#">Relays 1 and 2</a> on page 27)!</p>
	<p>10% – 90%: These LEDs display the calculated filling level of the indicator bottle (also see the section entitled “<a href="#">Measuring fault analysis</a>” on page 39).                      E4 – E1: These LEDs display current errors after simultaneously pressing key 3 and key 4 for approx. 2 seconds (also see the section entitled “<a href="#">Error messages/Troubleshooting</a>” on page 36).                      E4 flashes: The pump head has been in operation for 150 hours and must be replaced (also see the section entitled <a href="#">Pump head maintenance message</a> on page 44)</p>

**NOTE**

### Cancelling error messages/warning messages

- Press key 4 to acknowledge the messages and, if necessary, eliminate the cause of the fault.



**NOTE**

### Level indicator

As both reagents are usually consumed evenly during the analysis, the level indicator is valid for both reagent bottles. Therefore, always replace both bottles, even if some reagent is still present in one bottle.

If the bottles empty at different rates, an error has occurred. Check the suction lines.

## Installation



**WARNING**

### Risks resulting from incorrect installation!

- Install Testomat® 808 SiO<sub>2</sub> at a location where it is protected against dripping or splash water, dust and aggressive substances – e.g. in a control cabinet or on a suitable wall.



**NOTE**

### Information for trouble-free operation

- Install Testomat® 808 SiO<sub>2</sub> vertically and without mechanical stress.
- Install Testomat® 808 SiO<sub>2</sub> at a vibration-free site.

## Installing attachable shell

If you are using standard 100 ml bottles, you do not need the receiving table. The two bottles fit side by side in the device.

Install the receiving table if you are using 500 ml indicator bottles. In this case, one indicator bottle is placed in the device, while the other indicator bottle is placed on the receiving table.

- There are two mounting holes ① in the rear wall of the device. Screw the receiving table to the rear panel using the screws supplied.
- Feed one of the two indicator tubes from the oval opening in the rear wall ②. We recommend that Reagent B be put on the receiving table.
- Insert the extension hose with hose nipple ③ onto the indicator tube coming out of the rear panel.

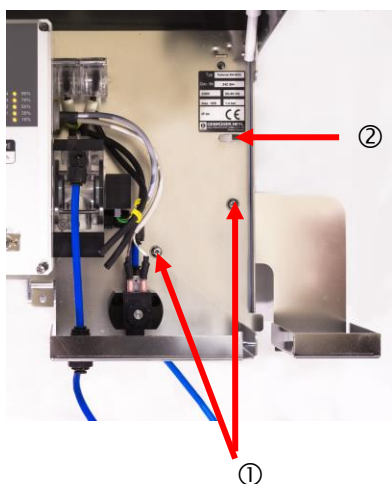

## Installing Testomat® 808 SiO<sub>2</sub>

Select an installation site where the water inlet hose can be kept as short as possible (max. 5 m).

- Drill the mounting holes as shown in the drawing below.
- Use three screws to attach the instrument at a suitable position on the wall.

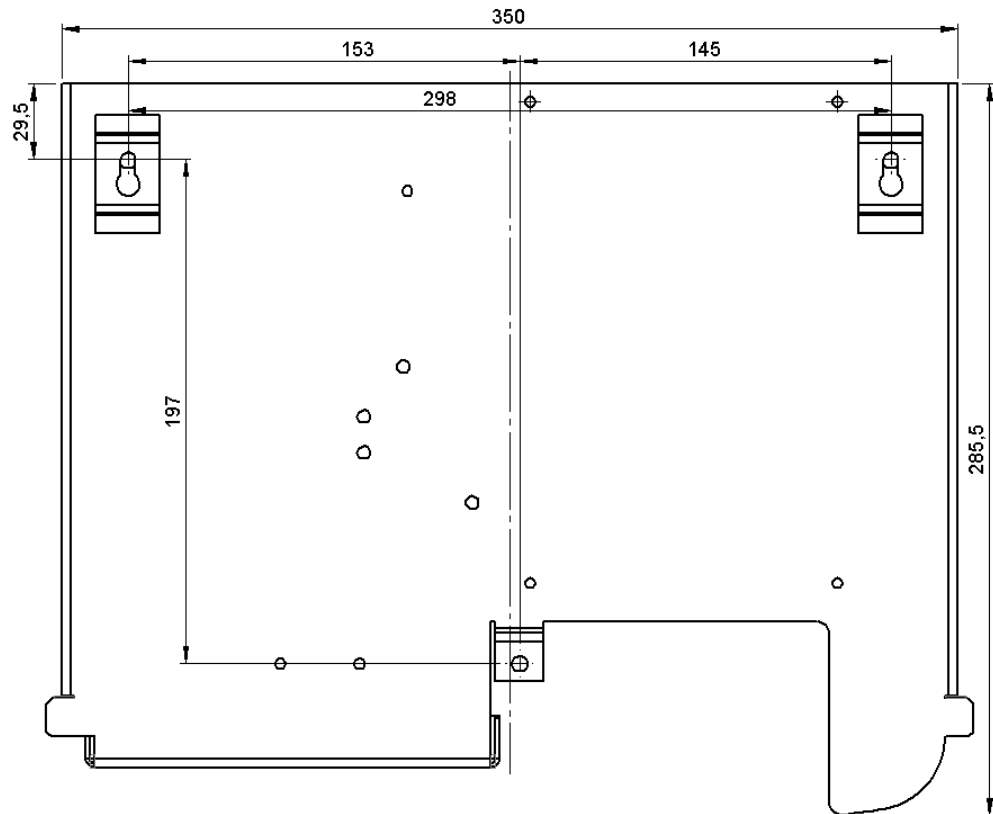

### Operating Testomat® 808 in the pressure range 4 to 8 bar

Prior to installation, please check whether a higher operating pressure (between 4 and 8 bar) is required. Use a pressure controller (art. no. 37602) for ranges between 4 and 8 bar. Optimum operation of Testomat® 808 SiO<sub>2</sub> is achieved with operating pressure of between 2 and 4 bar.

#### NOTE

#### Information for trouble-free operation

- The water pressure must be between 1 and 8 bar; a pressure reducer should be used for the 4 to 8 bar range (special accessories). This pressure regulator must be set under flow pressure!
- Avoid strong pressure fluctuations.



## Connecting the water inlet and outlet

### Information for trouble-free operation

- Ensure there are no foreign particles bigger than 150 µm which caused blocking. Use our candle filter (art. no. 37583) at the front end of the device if you have problems with blocking.
- The measuring water temperature must be between 10°C and 40°C.

### Water inlet



outlet

inlet with  
filter

The measuring water is taken from the main water line of the water treatment plant and fed to the inlet connection of Testomat® 808 SiO<sub>2</sub>. The instrument is equipped with a plug connector for plastic hoses 6/4 x 1 (external diameter 6 mm/ internal diameter 4 mm, wall thickness 1 mm) as standard).

- Install the connection for the branch line of Testomat® 808 SiO<sub>2</sub> directly at the main water line directly after the water treatment plant.
- Always lay the branch line connection vertically upwards in order to prevent dirt particles from entering the instrument from the main water line.
- We recommend you to install a manually operated stop valve (see figure [Plant example Testomat® 808 SiO<sub>2</sub>](#) on page 16) in the branch line to Testomat® 808 SiO<sub>2</sub>.
- Use an opaque plastic hose 6/4 x 1 (max. length 5 m) for the water inlet.
- Flush the supply line to remove any dirt particles.

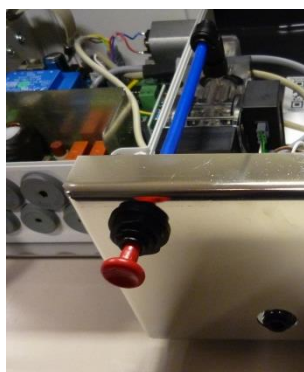

**NOTE**

### Water outlet

The feed water flows through the measuring chamber to the drain via the outlet hose.

- Remove the red plug from the outlet connection.
- Connect the outlet connection of Testomat® 808 SiO<sub>2</sub> to an outlet hose (internal diameter 4 mm).
- Feed the hose to an outlet.

### Transportation plug!

The outlet is sealed with a plug to prevent leakage during transportation. Keep and store the plug for possible transportation at a later date.

## Connecting the power supply and devices



**DANGER**

### Installing the terminal compartment cover

For technical safety reasons, the terminal compartment cover must be put back in place immediately after connecting the mains voltage and the system components, since the terminal space houses cables that carry dangerous voltages. This helps prevent inadvertent contact with the terminals and contact between the individual lines that may carry different voltages and thus avoid the risk of a life-threatening electric shock.

**Also ensure that the cable is not pinched when installing the terminal compartment cover!**



**WARNING**

### Risk of electric shocks during installation!

If the power supply is not disconnected prior to installation, it may result in personal injuries, destruction of the product or damage to plant parts.

- Always disconnect the relevant plant parts before installing Testomat® 808 SiO<sub>2</sub>.
- Only use tested cables with sufficient cross-sections for the connections.

### Disconnecting device for the power supply

The unit has no power switch!

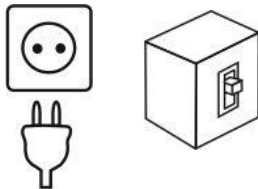

- Fit the Testomat® 808 SiO<sub>2</sub> with a switch as a disconnecting device for the power supply. Use an appliance switch or a circuit breaker that meets the requirements of IEC 60947-1 and IEC 60947-3.

The switch must be within easy reach of the user of the Testomat® 808 SiO<sub>2</sub> and clearly marked as a disconnecting device for the Testomat® 808 SiO<sub>2</sub>.

**NOTE**

### Risk of damages caused by electromagnetic fields!

- If Testomat® 808 SiO<sub>2</sub> or the connecting cables are installed parallel to power cables or in close proximity to strong electromagnetic fields, the instrument may be damaged or measurements incorrect.
- Ensure that connecting cables are as short as possible.
- Always install connecting cables and power cables separately.
- Connect the instrument to the protective earth conductor (for 230/115 VAC).
- Shield the instrument against strong electromagnetic fields.

## Connecting the mains voltage

Only connect the instrument to the specified mains voltage. Refer to the rating plate for the appropriate mains voltage. Connect the cables as follows:

- Open the housing cover and subsequently loosen the two fastening screws at the top and bottom of the door to the interior of Testomat® 808 SiO2. The door can now be opened and the terminal box accessed.
- Loosen the cable ducting strain relief (union nut).
- Remove the closing plugs.
- Lay the cable through the cable ducting underneath the housing into the terminal box.
- Tighten the union nut of the cable ducting and so establish the strain relief.
- Connect the power supply to the terminals PE, N, L.
- To do so, insert the conductors into the round cable input at the terminal block. Ensure that the strands are held securely in the terminals.
- To loosen the connection, insert a screwdriver into the square opening without force in order to open the terminal. Once the terminal has been opened, remove the conductor.

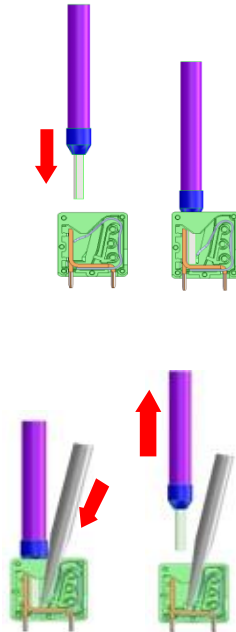

Terminal description	Type	Function	Comment
PE ⊕	IN	Mains protective earth (4x)	Only with mains 115/230 V !
N (U) L (V)	IN	Mains, N=neutral (U=24 V) Mains, L=live (V=24 V)	Mains input 50-60 Hz 24 V / 115 V / 230 V
n l	OUT	Neutral, protected with 4A (3x) Live, protected with 4A (3x)	Mains for consumers, max. 4 A

C NO NC	C NO NC	C NO NC

L N ⊕	l n ⊕	l n ⊕	l n ⊕

STOPP	EXT. LÖSCH.	I-IN	I-OUT

### Terminal labelling

- C = common – shared
- NC = normally closed – contact breaker
- NO = normally open – contact opener



## Connecting the inputs and outputs



### Connecting the inputs

- Do not connect external voltage to these connections!

Testomat® 808 SiO2 has the following connections for control and monitoring functions.

- Ensure that the strands are held securely in the terminals.
- Use the two fastening screws to close the door once installation has been completed.

Terminal description	Type	Function	Comment
RELAY 3	OUT	Fault message output – change-over contact	Volt-free relay output*
RELAY 2	OUT	switches if filter 2 is depleted	Volt-free relay output*
RELAY 1	OUT	switches if filter 1 is depleted	Volt-free relay output*
EXT. DEL.	IN	Acknowledgment message input – normally open	Volt-free input
STOP	IN	Flow controller/Switch input – normally open	Volt-free input

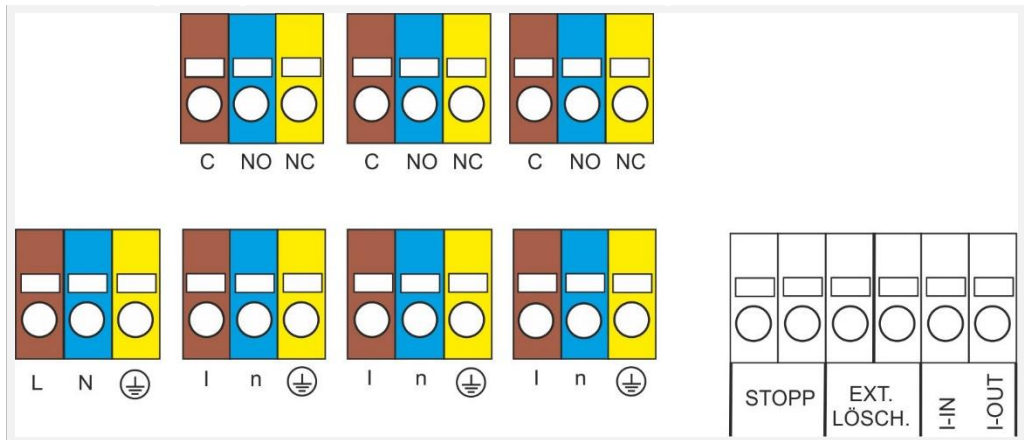

\* Please refer to the section entitled [Technical data](#) on page 48 for the maximum contact load of the relays.

Please refer to the section entitled “[Description of the signal inputs](#)” on page 25 or “[Description of the relay outputs](#)” on page 26 for a detailed description.

## Examples of a hospital sterilisation system with integrated silicate measurement after permeate tank

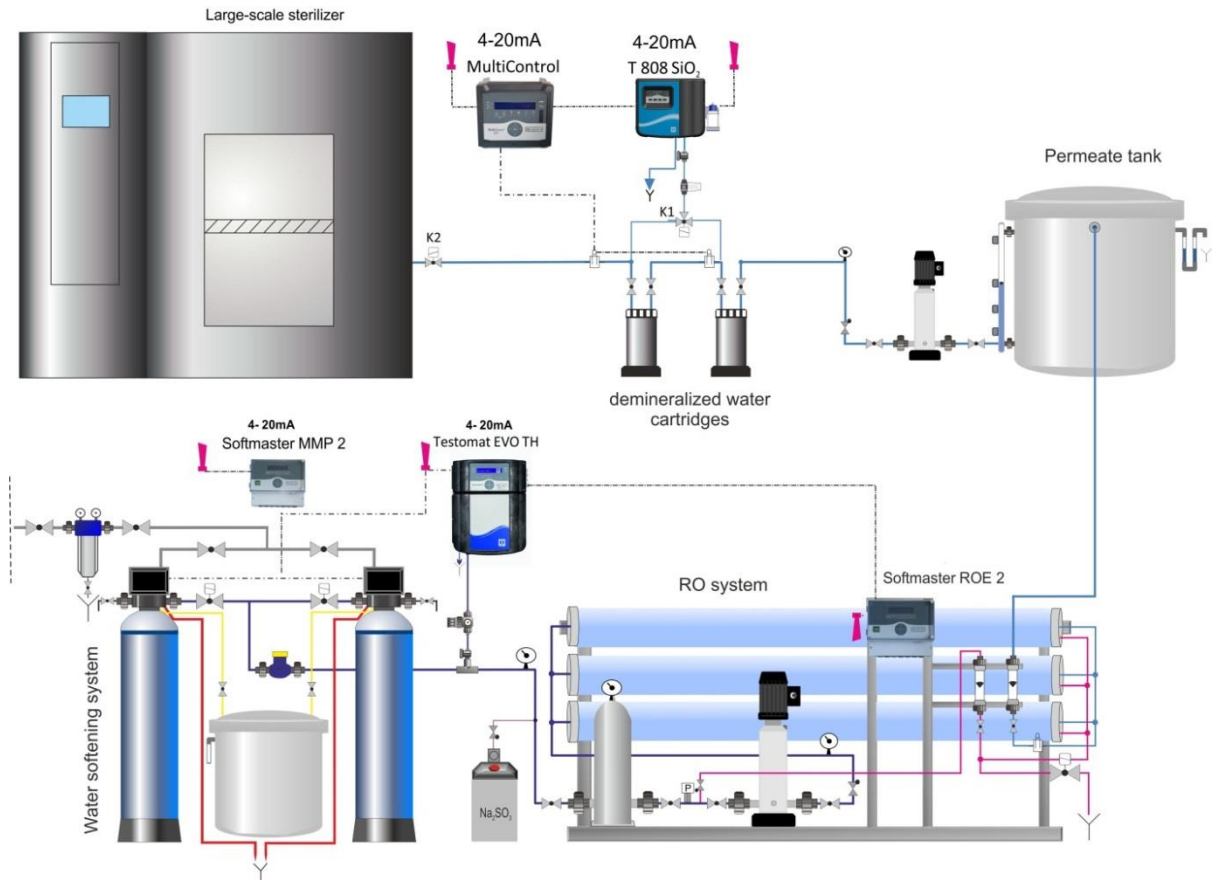

## with integrated silicate measurement before permeate tank

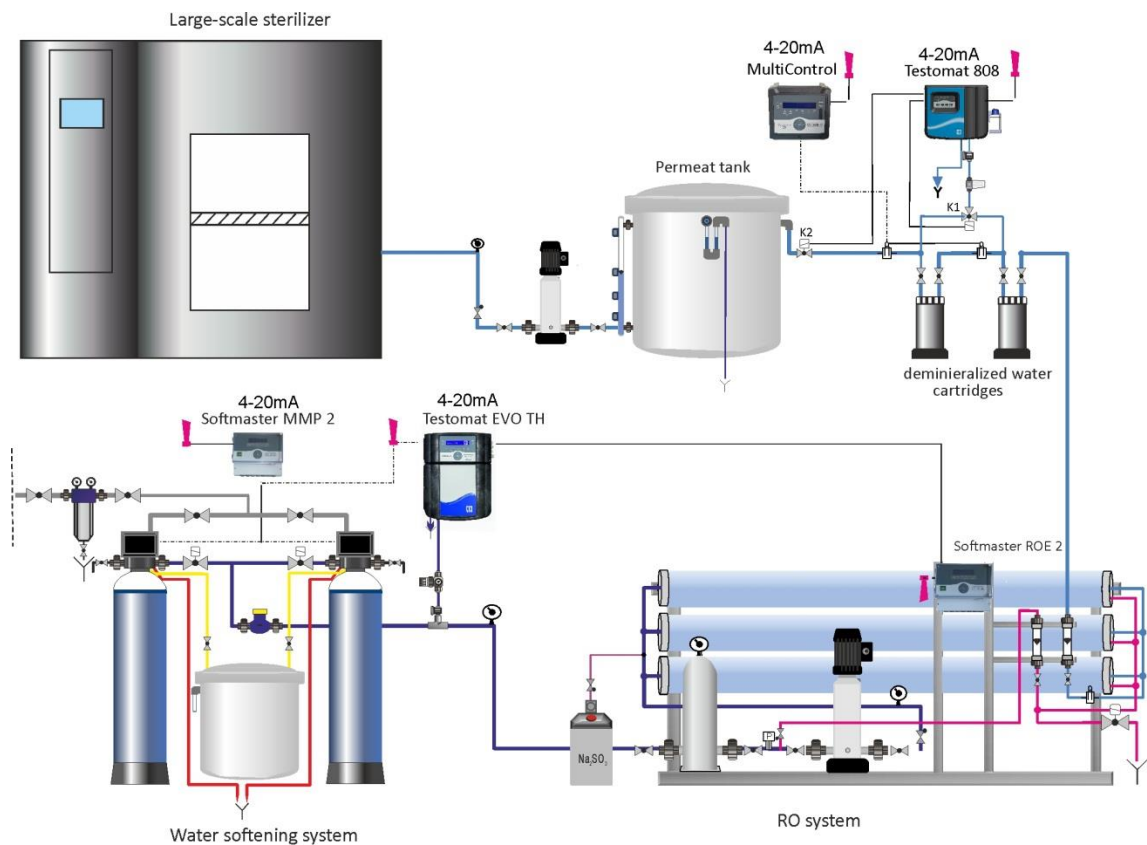

with integrated silicate measurement after EDI

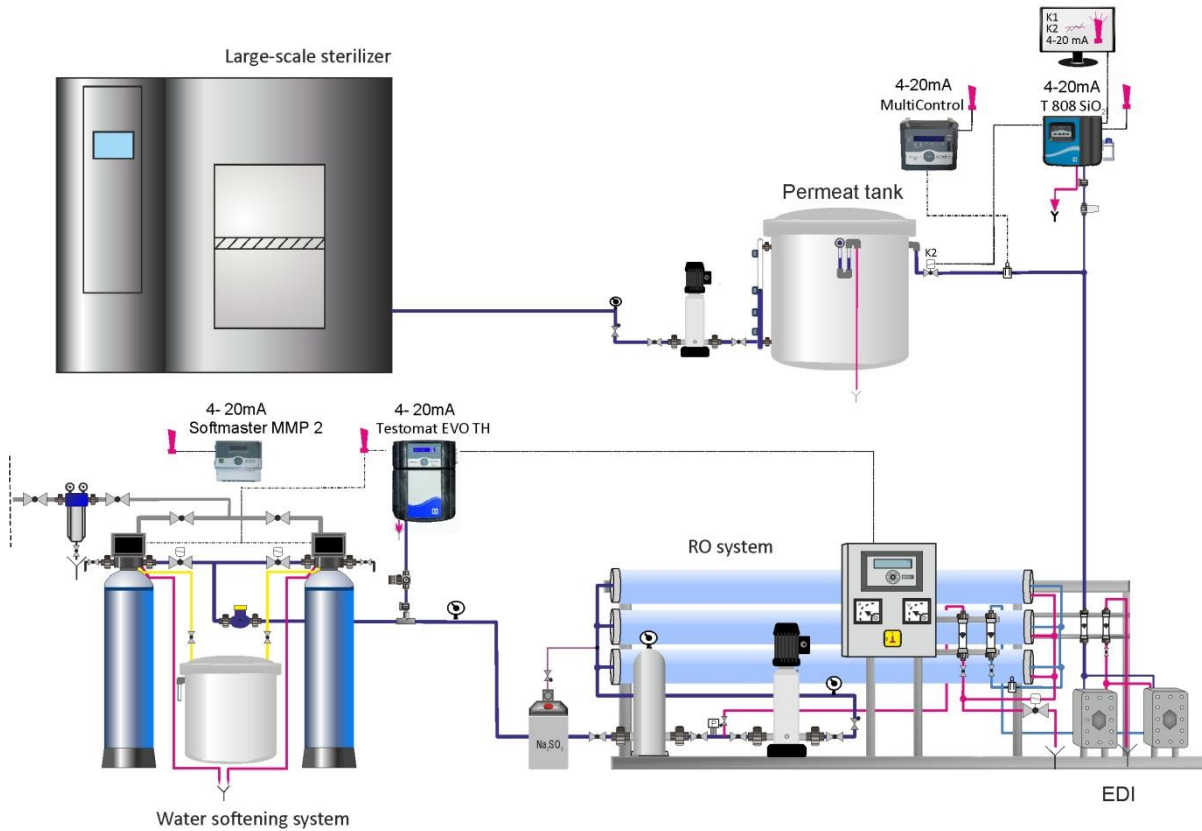

### Diagram of a silicate measurement with Testomat® 808 SiO<sub>2</sub>

as shown in Figure 1 and 2 on page 18

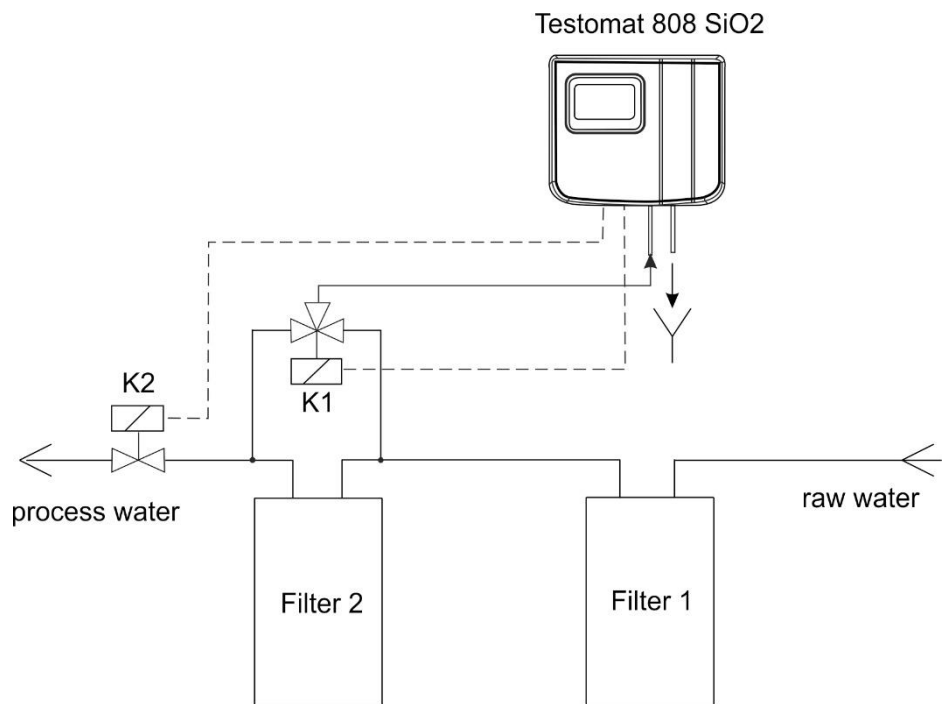

# Internal design Testomat® 808 SiO2

## Rear of the controller board

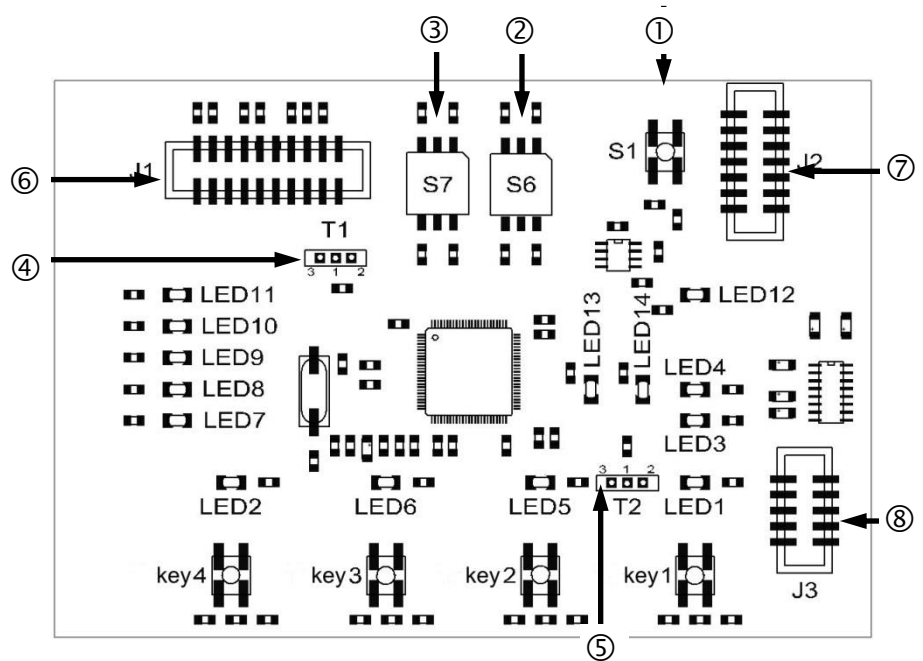

Keys 1 to 4 are located at the front of the board. Please refer to the section entitled “[Functions of the operating and display elements](#)” on page 9 for a detailed description of its operating system and the display elements.

The following function keys and slide switches as well as plug connectors are also provided:

### Reset key S1

Use reset key S1 ① to execute a reset, i.e. to reset the firmware of Testomat® 808 after an update.

### Function key S6 (interval pause)

Use function key S6 ② to set the interval pause between measurements. Please refer to the section entitled “[Interval pause](#)” on page 34 for an overview of possible switching positions and interval pauses. (The standard setting is 6.)

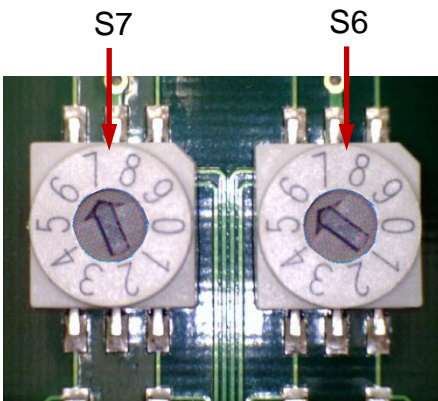

## Function key S7 (Measuring / monitoring area)

With the function switch S7 ③ you can set the desired limit for your measurements.

Position	Limit
0	0,3 ppm
1	0,4 ppm
2	0,5 ppm
3	0,6 ppm
4	0,7 ppm
5	0,8 ppm
6	0,9 ppm
7*	1,0 ppm
8	1,1 ppm
9	1,2 ppm

\* Default

### NOTE

#### Switch position

- The respective switch position is read after evaluating a measuring result and after a reset.



Switch position left  
(delivery status)

#### Slide switch T1

**Switch position LEFT:** If the slide switch ④ is in the left position and the instrument is switched on or the reset key pressed while the instrument is switched on, the microcontroller executes the operating program (firmware).

**Switch position RIGHT:** If the slide switch ④ is in the right position and the instrument is switched on or the reset key pressed while the instrument is switched on, the instrument is set to a mode which enables a firmware update via the serial interface.

If your instrument requires a firmware update, Heyl will provide you with further detailed information.

### NOTE

#### Switch position

- The switch position is only read immediately after a reset.



Switch position right  
(delivery status)

## Slide switch T2

Use the slide switch T2 ⑤ to determine the size of the indicator bottle. The following indicator bottle sizes are possible:

Indicator	Switch position
100 ml bottle	Left
500 ml bottle	Right

### NOTE

#### Switch position

- The status of the slide switch T2 is read after resetting the indicator display to 100% and after a reset.

## Plug connector J1

The plug connector J1 ⑥ is a programming interface. It is not important for instrument operation.

## Plug connector J2

The connection to the base circuit board is established via the plug connector J2 ⑦ using a ribbon cable.

## Plug connector J3

The connection to the RS232 interface is established via the plug connector J3 ⑧ using a ribbon cable. Please refer to the section entitled “[Serial interface RS232](#)” on page 26 for a detailed description.

## Base circuit board Testomat® 808 SiO2

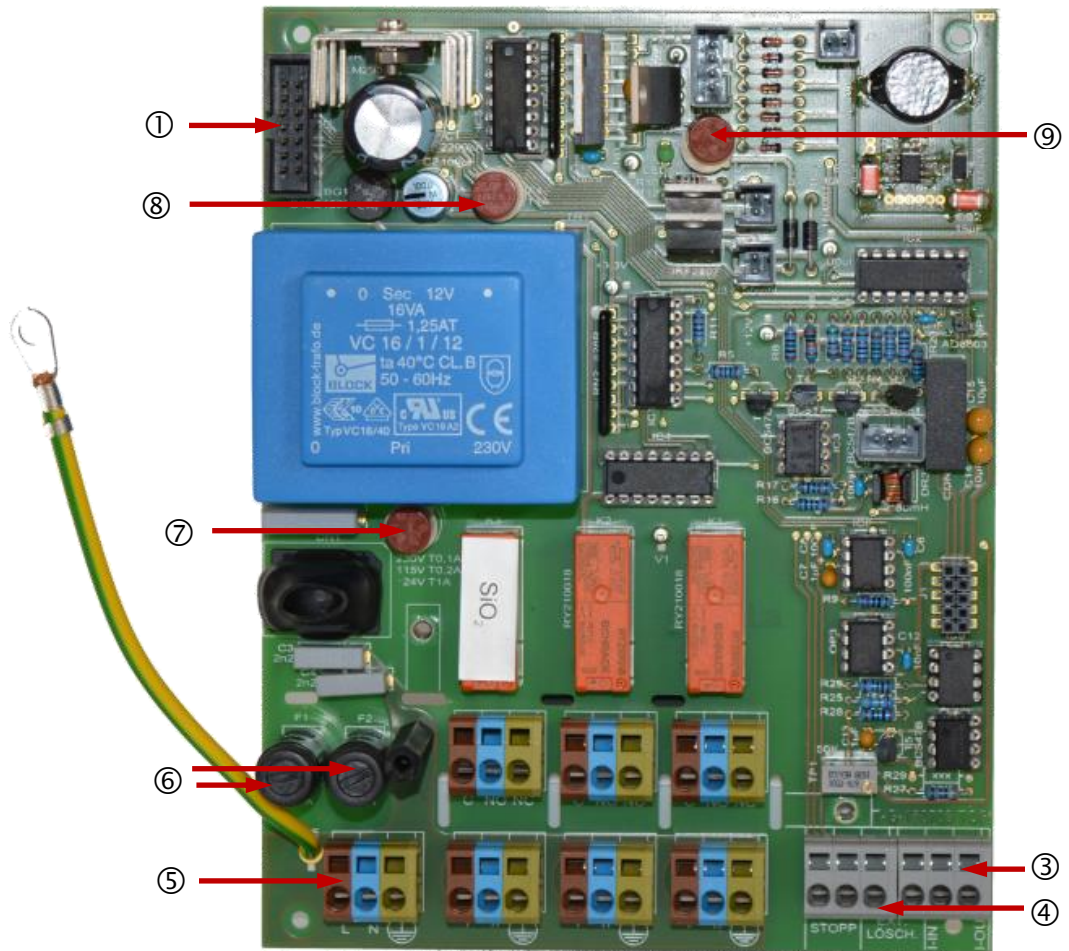

The illustration above provides an overview of the design of the base circuit board.

### Plug connector J2

The connection to the controller board is established via the plug connector J2 ① using a ribbon cable.

### Current interface

Please refer to the section entitled “[Interfaces](#)” on page 25 for a description of the current interface ③.

### Inputs DEL. EXT. and STOP

Please refer to the section entitled “[Description of the signal inputs](#)” on page 25 for a description of the inputs “Delete externally” and “Stop” ④.

## Terminal block

Please refer to the sections entitled “Connecting the power supply and devices” on page 24 and [Connecting the inputs and outputs](#) on page 17 for a description of the terminal block ⑤.

## Fuses

The following fuses can be found on the base circuit board.



No.	Designation	Function	Comment
⑥	F1 F2	Relay protection fuse	4 A
⑦	F3	Primary fuse	230 V / 0.1 A 115 V / 0.2 A 24 V / 1 A
⑧	F4	Secondary fuse	1 A
⑨	F5	Relay protection pump head	0.315 A

Please refer to the section entitled “Testomat® 808 SiO2 2019 spare parts and accessories” on page 46 for the article numbers when re-ordering fuses.



## Description of the signal inputs

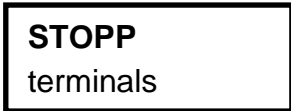
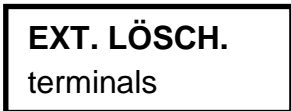
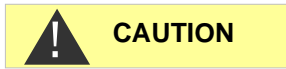

### Connecting the signal inputs

- Only connect the signal inputs “Delete externally” and “Stop” to *volt-free* contacts!

The connection of external voltages would damage the instrument!

### DEL. EXT. (EXT. LÖSCH.) of relay 3

The input “Delete externally” is used for the external deletion/acknowledgment of current errors/alarms. It reacts the same as key 4 (horn) after a short press, i.e. all fault messages can also be acknowledged via a remote control (normally open).

### STOP

The input “Stop” is the input for an external flow controller or switch (volt-free, normally open). It reacts the same as key 3 (pause) after a short press. The LED above key 3 flashes and the instrument no longer executes analyses. However, an analysis currently in progress will be completed.

### Priority of input STOP

- The external stop function has priority over key 3 (pause)!
- If the standby function (key 3) has been activated and subsequently deactivated during an analysis pause, the interval pause time is reset. However, if the standby function is terminated via the “Stop” input, the analysis starts immediately.

## Interfaces

### Current interface

The results of the analyses or statuses can be registered via the output of the current interface (I-OUT (+) / I-IN (-)). The following defined values for status and error messages are output for this:

- 4 mA = after connecting, before the first measurement
- 5 mA = everything OK
- 8 mA = Filter 1 exhausted
- 11 mA = Filter 2 exhausted
- 14 mA = Low water level
- 17 mA = Low indicator level (< 10%)
- 20 mA = Indicator is empty or optical fault or no or insufficient indicator in the measuring chamber

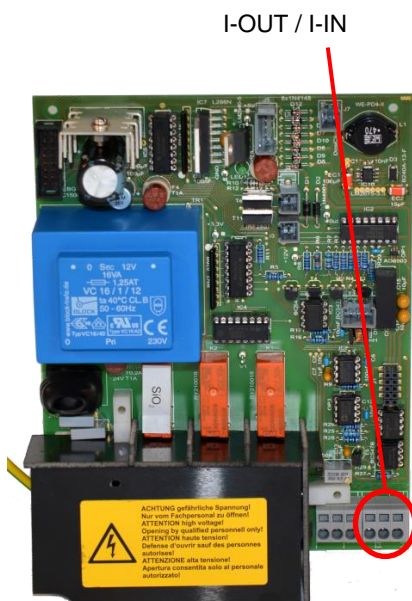

**NOTE****Current interface load**

- The current interface is galvanically decoupled. A maximum load of 500 Ohms should not be exceeded!

For faults and when using very long cables (approx. 20 m), a screened cable should be used if possible.

**Serial interface RS232**

The serial interface RS232 is located at the front of Testomat® 808 SiO2 (after opening the housing cover). Use a ribbon cable with a 9-pole Sub-D connector to connect the plug J3 on the controller board to RS232. Use this RS232 interface to connect a computer/notebook to the controller board of Testomat® 808 SiO2 via a null modem cable and update the instrument's firmware.

Using the appropriate software, measurement data can be logged to a desktop or notebook computer via this interface

## Description of the relay outputs

All relay outputs are neutral contacts. This ensures that all connection options are available. The switching of mains voltage and external voltage, and the direct switching of inputs, e.g. a process controller, can thus be realised. Please refer to the chapter entitled [Technical data](#) on page 48 for the maximum load of the relays.

**Relay 3 – fault message**

Relay 3 is designed as a change-over contact and used for fault messages indicating low water level, low indicator level and power failure.

## Relays 1 and 2

Two volt-free relay contacts are available to signal that a limit value has been exceeded.

- To release relays 1 and 2 again, press and hold down button 2 (INIT).

### Handling good and bad measurements

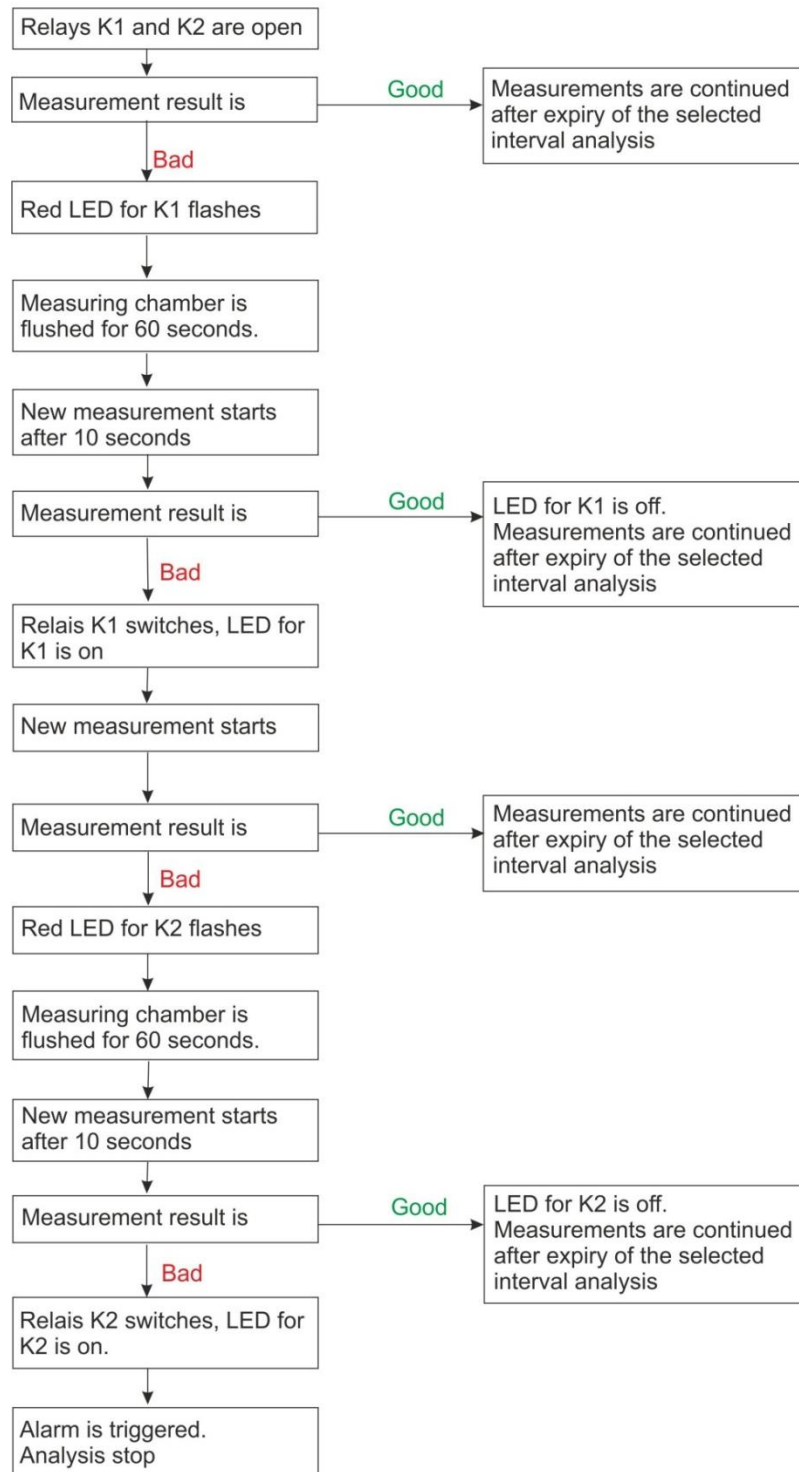

## Commissioning

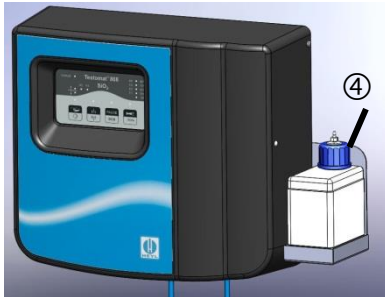

### NOTE

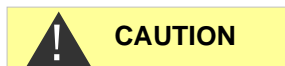
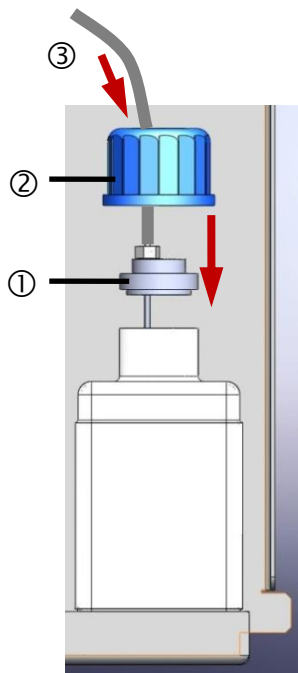

### Handling reagents/indicators

- Please adhere to the respective safety data sheet!
- Trouble-free operation of Testomat® 808 SiO<sub>2</sub> is only guaranteed when using Heyl Testomat® indicators!

### Inserting the reagent bottles

- Open the housing cover to access the housing.
- Remove the cap from the reagent bottles.
- The supplied plastic bag contains two blue screw caps with a hole and the respective insert for the reagent bottle (500 ml).

### Pay attention to bottle height!

There are two inserts. One is for the 100 ml bottle (spare part) and the other one is for the 500 ml bottle (scope of delivery). The length of the suction tube indicates which insert is for which bottle. Select the insert that matches your bottle. When inserted, the suction tube should almost reach the bottom of the bottle.

- Insert into a reagent bottle ① for each use.
- Turn each blue screw with hole ② on a reagent bottle until hand-tight.
- When using 100 ml bottles, put Reagent A and Reagent B into the housing next to the water inlet. When using 500 ml bottles, put Reagent A into the housing and Reagent B on the receiving table ④ next to it on the right (see also [Installing attachable shell](#)).
- Slide each suction hose ③ firmly onto the hose connector of the insert, so that both indicator bottles are connected to the double hose pump. When using 500 ml bottles, extend the hose to Bottle B using the extension piece and inserted hose nipple.

### Mixed-up hoses clog up!

Always be sure to use Hose A for Reagent A, and Hose B for Reagent B. When they are mixed up, Reagent B crystallises with remnants of Reagent A and clogs up the hose and dosing needle. Error E2 is displayed.

Thoroughly flush the hoses with plenty of warm water before carrying out a new analysis.

## Bleeding the lines

To ensure that reagent is available for the initial analyses, the intake hose and the transport hose must be filled with reagents from the pump up to the measuring chamber.

- Switch on the instrument and press key 3 (pause). The standby function is switched on or off via a short key press. The LED above the key flashes if the function is active.
- Press key 1 (manual) for longer (approx. 2 seconds) to bleed the lines. The dosing pump starts to run.
- Let the pump run until no more bubbles escape from the dosing needle. Then press key 1 (manual) again for approx. 2 seconds to switch off the pump.

During operation, the pump automatically extracts the reagents.

## Opening the water inlet

- Slowly open the manual stop valve in the water line to open the water inlet.

### NOTE

---

### Insert cartridge filter into the supply line

We recommend that the supplied cartridge filter be installed in the supply line of the Testomat® 808 SiO<sub>2</sub> to prevent any resin beads rinsed out from the filters from clogging up the solenoid valve.

---

# Instrument settings and analysis

Please read the following information before carrying out the required settings at the instrument.

## Instrument settings

The required instrument settings for executing analyses, e.g. measuring interval pause, reagent bottle size and limit value, are carried out on the controller board using the function keys and slide switches. Please refer to the section "[Internal design Testomat® 808](#)" on page 20 for a detailed description.

- Make the desired settings for
  - Interval pause,
  - Container size and
  - Limit
 before you start an analysis.

### NOTE

#### Double assignment of the function keys

- The four function keys at Testomat® 808 for instrument operation basically have two functions.
- A short or long key press (at least 2 seconds) is required for operation.

A short key press activates the top functional level (displayed in black on the key). A long key press is required to activate the bottom key function (displayed in white). Please refer to the section entitled [Functions of the operating and display elements](#) on page 10 for a description of the individual functions.

### NOTE

#### Displaying operating statuses and measuring results

- Only LEDs are used to display operating statuses and measuring results at Testomat® 808 SiO<sub>2</sub>.
- Depending on the status or measuring result, the LEDs can either flash or illuminate continuously (see the section entitled [Operating elements/Function keys](#) on page 11).

### NOTE

#### Limit value display

- Testomat® 808 SiO<sub>2</sub> is a pure limit value measuring instrument which uses two limit value LEDs to display the measuring result.



The green LED illuminates when the limit value specified by the selected indicator is not achieved during the analysis.

The red LED illuminates if the limit value is exceeded.

If a new measurement is running after completion of another measurement, the result of the previous measurement flashes in the display. The respective LED displaying the result of the previous measurement illuminates continuously during the interval pause.

Both LEDs are switched off if an error occurred during the previous measurement.

## Selecting the indicator type and bottle size

### NOTE

### Specifying the measuring/monitoring range of Testomat® 808 SiO<sub>2</sub>

- The measuring/monitoring range (limit value) of Testomat® 808 SiO<sub>2</sub> is specified by the function key S7 (see chapter Function key S7 (Measuring / monitoring area)).

The reagents are available in two bottle sizes. To specify the size of the bottle, move slide switch T2 on the rear of the controller board to the respective switch position (see the section entitled "[Internal design Testomat® 808](#)" on page 20):

Bottle size	Switch position	Number of measurements
100 ml bottle	Left	approx. 145
500 ml bottle	Right	approx. 725

### NOTE

### Switch position

- The status of slide switch T2 is read after resetting the reagent level to 100% and after a reset.

### NOTE

### Set reagent level to 100%

- After selecting the bottle size and inserting the bottle, press key 4 (horn) to set the display for the reagent level to 100%.

## Carrying out an analysis

After switching it on, the instrument commences automatic interval mode. The first analysis starts after 15 seconds. The following analyses start automatically according to the set interval pause.

### NOTE

### Duration of the interval pause

- The duration of the interval pause between two measurements can be set between 0 and 480 minutes, also see the section entitled "[Interval pause](#)" on page 34.
- **Attention!** After a poor analysis, the interval pause is ignored in some switching positions of function key **S6** and **another** analysis is carried out immediately (see [Relays 1 and 2](#) - Handling good and bad measurements).

Automatic interval mode can be interrupted via standby and analyses started manually.

Operating mode	Function/Process
<b>Standby</b>	Short press key 3 (pause) to switch standby on/off. <b>Note:</b> During an interval pause, the instrument immediately switches to standby; a started analysis is always completed.
<b>Manual</b>	Precondition: The instrument is in standby or in an interval pause. Short press key 1 (manual) to switch on manual mode. An analysis is started immediately, irrespective of the set interval pause.

## Analysis process

The analysis takes approx. 2 minutes. The water analysis process for determining the residual total hardness is as follows:

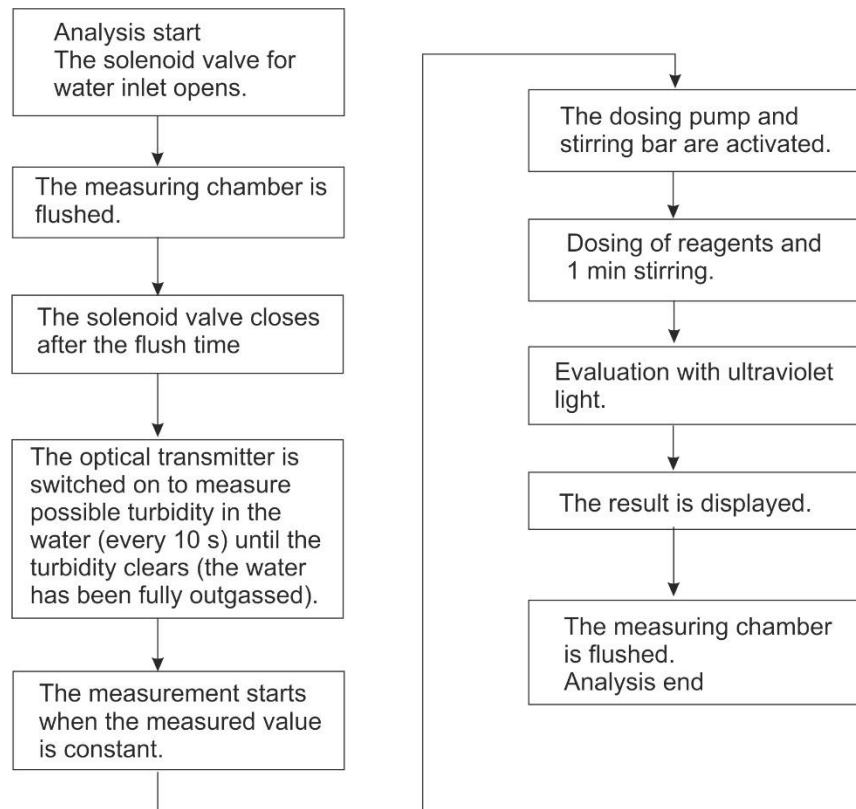



## Further basic functions and settings

### Internal flushing

To ensure that the analysed sample represents the current value, the sampling line must be sufficiently flushed.

#### NOTE

#### Duration of the internal flush time

- The duration of the internal flush time is preset (10 s before and after a measurement) and cannot be influenced by the operator.

The quantity of flush water for internal flushing depends on the pressure:

Pressure	Max. water quantity per analysis
1 bar	80 ml
2 bar	120 ml
3 bar	160 ml

### Flush process – manual mode

Proceed as follows to additionally flush the instrument:

- At first switch the instrument into standby mode for flushing. Short press key 3 (pause) to achieve this.
- If a measurement is running, wait until the measurement has been completed.
- Short press key 2 (Flush) to open the internal flush valve.

The valve opens and the measuring chamber is flushed.

The LED above key 2 (Flush) flashes as long as the internal flush valve is activated.

- Short press key 2 (Flush) again to terminate the flush process.

## Interval pause

If the analysis is started via a timer, the interval between two analyses (plus flush time) is determined by the interval pause. The shortest interval can be 0 minutes. In this case, analyses are carried out continuously. The longest interval is 480 minutes.

Set the desired measuring interval pause via function key S6 on the controller board (see the section entitled "[Rear of the controller board](#)" on page 20). The following switching positions and interval pauses are possible:

Position	Interval pause
0	0 min.
1	15 min.
2	30 min.
3	45 min.
4	60 min.
5	90 min.
6*	120 min.
7	240 Min.
8	360 Min.
9	480 Min.

\* Delivery status

### NOTE

#### Switch position

- The current switch position is read after evaluating a measuring result and after a reset.

### NOTE

#### Resetting the interval pause time

- However, if the standby function has been activated and subsequently deactivated during an analysis pause, the interval pause time is reset.

## 72 h operation (operation without permanent supervision)

If the instrument should run for a longer period of time without supervision (e.g. at the weekend), use this function to check whether sufficient indicator is available for a continuous measurement.

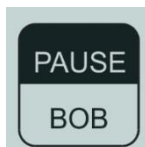

On the basis of the still available indicator, the set indicator pause and indicator quantity consumed per measurement, the instrument calculates whether the residual indicator quantity is sufficient for the next 72 operating hours.

- Press key 3 (pause) for approx. 2 seconds to check whether 72 h operation is possible.

72 h operation possible	72 h operation not possible
The LED above key 3 (pause) illuminates for 4 seconds.	The LED above key 3 (pause) flashes quickly for 4 seconds.

## Error messages/Troubleshooting

### Alarm/Error message/Relay 3

Testomat® 808 SiO<sub>2</sub> uses LEDs which either illuminate continuously or flash to display alarm/error messages.

#### NOTE

#### Error messages

- All status/error messages are lost after a power failure!
- Current error messages can be confirmed by pressing key 4 (horn) briefly or via input DELETE EXT. (page 22).
- We recommend you to carry out a manual analysis after an error message to determine whether the error has been eliminated or not. Further steps as described below.

Activate the red alarm LED above key 4 (horn) as follows:

LED	Cause
Flashes	<ul style="list-style-type: none"> <li>• Calculation shows that the reagent level is zero</li> <li>• No or insufficient reagent in the measuring chamber after dosing</li> <li>• Optical fault</li> <li>• The instrument is operated outside of the specification (e.g. low temperature or with expired reagents)</li> </ul>
Illuminates	<ul style="list-style-type: none"> <li>• Reagent level is between &gt;0 and 10%</li> <li>• All other errors</li> </ul>

Error messages are output via the current interface. The following status/error messages are possible:

After the first start (start-up) and before the first measurement is made	4 mA
Good measurement	5 mA
Filter 1 exhausted	8 mA
Filter 2 exhausted	11 mA
Low water level	14 mA
Low reagent level < 10% (acknowledgeable by pressing key 4)	17 mA
Reagent bottles are empty (not acknowledgeable) or optical fault or no or insufficient reagent in the measuring chamber or the instrument is operated outside of the specification (e.g. low temperature or with expired reagents)	20 mA

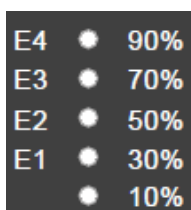

The individual errors can be displayed via the LEDs E1 to E4.

- To do so, simultaneously press key 3 (pause) and key 4 (horn) for approx. 2 seconds.

The following errors are displayed for 4 seconds:

LED	Cause	Remedy
E4	Insufficient LED power, insufficient light (or hardware error)	<ul style="list-style-type: none"> <li>➤ Check whether the water is turbid. Strong turbidity can negatively influence the measurement.</li> <li>➤ Check whether the measuring chamber/sight glass is soiled.</li> <li>➤ The sensor or LED might be damaged.</li> <li>➤ Check whether the water level is too low.</li> <li>➤ Check whether the measuring chamber and the LED fitting have been installed correctly. These elements can loosen during transport. The measurement is no longer being carried out correctly.</li> <li>➤ If necessary, carry out a visual adjustment as described in the maintenance instructions for the Testomat® 808 SiO2.</li> </ul>

LED	Cause	Remedy
E3	Excessive LED power, excessive light (or hardware error)	<ul style="list-style-type: none"> <li>➤ Close the housing cover. The environment is too bright (sunlight), thus negatively influencing the measurement.</li> <li>➤ The sensor or LED might be damaged.</li> <li>➤ If necessary, carry out a visual adjustment as described in the maintenance instructions for the Testomat® 808 SiO<sub>2</sub>.</li> </ul>
E2	Measuring fault analysis	<ul style="list-style-type: none"> <li>➤ Check whether the reagent bottles are empty.</li> <li>➤ Does the reagent level display match the reagent quantity in the bottle?</li> <li>➤ Check the reagents. Only use reagents which we have approved for use in the Testomat® 808 SiO<sub>2</sub>. Reagents for other Testomat instruments produce erroneous measurements or the error, "MST analysis".</li> <li>➤ Check whether the stirring bar is present and turns.</li> <li>➤ Check whether the pump supplies reagents.</li> <li>➤ Check whether the dosing needle is blocked or its O-ring is damaged. Make sure that the suction and pressure hoses do not draw secondary air. Check the suction lance. Make sure that no air bubbles are escaping from the dosing needle.</li> <li>➤ Check fuse F3 and replace it. If the fuse continues to trip, replace the pump motor.</li> </ul>
E1	Low water level	<ul style="list-style-type: none"> <li>➤ Make sure the water lines are not leaky.</li> <li>➤ Are the water lines connected properly?</li> <li>➤ Are all stop valves in the inlet open?</li> <li>➤ Ensure there are no foreign particles which caused blocking.</li> <li>➤ Very dirty or turbid water can also lead to error E1. Check the water quality. Use our particulate filter in the supply line. Clean the filter if necessary.</li> </ul>

### Low water level

The LED above key 4 (horn) illuminates if the water level is low. The low water level is also registered via relay 3. Contacts C and NC are connected for this purpose.

- Press key 4 (horn) or close the contacts of the "Delete externally" input to confirm the alarm.

After confirmation, the LED extinguishes via key 4 and relay 3 is re-activated (contacts C and NO are connected).

#### NOTE

The alarm is also deleted without it being acknowledged once the low water level has been eliminated after the following analysis.

## Measuring fault analysis

- The red alarm LED above key 4 (horn) illuminates if the calculated reagent quantity is between >0 and 10%. This message is only output once and can be acknowledged by short pressing key 4 (horn) at the instrument or a contact via “Delete externally”.
- Both the red alarm LED and the standby LED (via key 3) flash when the calculated reagent quantity is zero. The external inputs “Stop” and “Delete externally” are ignored. You now have to replace the reagent bottles (see the section entitled “[Replacing the reagent bottle](#)” on page 42).
- The LED above key 4 (horn) flashes and the instrument goes into standby mode if the measuring fault is due to lack of reagents. Damaged or bent lines can cause this error. The reagent bottles may also be empty if the reagent level has been set incorrectly.

## Defective pump motor

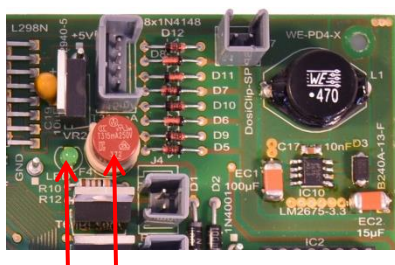

LED F5

The F5 fuse on the main board protects the pump motor. After a short circuit, the LED next to fuse F5 is off.

- Exchange the pump motor and F5 fuse.
- Check that the green LED is lit again.

**Caution!** The pump motor can also stop without a short circuit. This will not trip the F5 fuse. In the event of a **low indicator level** (measurement disruption analysis), always check the pump motor by pressing the ‘manual’ button down for 2 seconds. If the motor no longer turns, replace it.

## Further possible instrument errors

Error	Possible causes	Remedies
Instrument not functioning, even though it is switched on	<ul style="list-style-type: none"> <li>– Fuses F1, F2 or F3 defective</li> <li>– No voltage</li> <li>– Ribbon cable to controller board or base circuit board is loose</li> <li>– Error at controller board or base circuit board</li> </ul>	<ul style="list-style-type: none"> <li>➤ Replace fuses</li> <li>➤ Replace power switch</li> <li>➤ Reconnect ribbon cable</li> <li>➤ Replace controller or base circuit board</li> </ul>

### Response of a protective circuit

After a protective circuit (fuse) has been tripped, attempt to eliminate the cause of malfunctioning (e.g. replace a defective valve) before reactivating the protective circuit. Frequent tripping is always due to an error which, in certain circumstances, may also cause damage to the instrument.

---

### **Malfunctioning/Repairing a defective instrument**

The repair of a defective instrument – irrespective of the warranty period - is only possible when the instrument is dismantled and returned to us with a description of the error. Please also inform us about the currently used indicator.

- Before you return the instrument for repair work, remove the bottle and ensure that the measuring chamber has been flushed out and is empty.
- Insert a transportation plug into the outlet pipe to prevent leakage.
- Use the enclosed error log to describe the error and return it to us together with the instrument. If the error log is no longer available, download it at [www.heylanalysis.de](http://www.heylanalysis.de).



## Maintenance

### NOTE

#### Required maintenance measures

- Regular maintenance is necessary to ensure trouble-free operation of the instrument (every six to twelve months)!

At least carry out the maintenance work described in the following section on a regular basis when

- the instrument displays the following error messages:  
“Insufficient/Excessive light”, “Low water level” or “Low indicator level”
- the last maintenance was carried out no more than six months ago.



### CAUTION

#### Cleaning measures

- Never use organic solvents to clean the measuring chamber or other plastic parts!
- Always observe the safety regulations when handling cleaning agents!
- As a result of continuous operation, a coloured film may form on the sight-glass windows. Use isopropanol to remove this sticky film.

Maintain the following components at the respective interval:

Component	Maintenance interval
both pump heads	<ul style="list-style-type: none"> <li>• Replace if LED E4 flashes with “pump head maintenance”</li> </ul>
motor block	<ul style="list-style-type: none"> <li>• Replace together with pump heads.</li> </ul>
measuring chamber	<ul style="list-style-type: none"> <li>• Check for cleanliness and tightness (see page 43).</li> </ul>

#### Service instructions

The surface of the instrument has not been treated. Therefore, avoid any soiling caused by indicators, oil or grease. However, if the housing becomes soiled, please clean the surface with a commercial plastics cleaner (never use other solvents).

## Description of maintenance work

Carry out the maintenance work described below on a regular basis.

### NOTE

#### Bleeding the lines

- Bleed the lines after each mechanical step to ensure trouble-free operation of the instrument. To achieve this, proceed as described in the section entitled "[Replacing the reagent bottle](#)" on page 42!

#### Replacing the reagent bottles

If Testomat® 808 SiO<sub>2</sub> displays the error message "Low indicator level", replace the reagent bottles (refer to the section entitled "[Error messages/Troubleshooting](#)" on page 36) for information about error messages). Proceed as follows:

- Put the instrument into standby mode. If a measuring process is currently running, wait until it has been completed.
- Proceed as follows to remove the empty bottles: disconnect the intake hose from the hose connector at the top of each bottle and remove the empty bottles.
- Insert the new bottles as described in the section entitled "[Inserting the reagent bottle](#)" on page 28.
- Bleed the lines after inserting a new bottle. To achieve this, press key 1 (manual) for approx. 2 seconds. The dosing pump starts to run.

Let the pump run until no more bubbles escape from the dosing needle. Then press key 1 (manual) again for approx. 2 seconds to switch off the pump.

### NOTE

#### Correct bottle size

- Make sure that the correct indicator bottle size is set via slide switch T2 (see the section entitled [Slide switch T2](#) on page 22)!

- After bleeding the lines, press key 4 (horn) for approx. 2 seconds to reset the internal analysis counter to 100%.

#### Resetting the analysis counter

Testomat® 808 SiO<sub>2</sub> automatically calculates the number of analyses depending on the set bottle size.

The instrument cannot measure the actual filling level of the reagent bottles!

- Only reset the analysis counter to 100% after inserting a new reagent bottle!



### CAUTION

## Cleaning the measuring chamber and the sight-glass windows

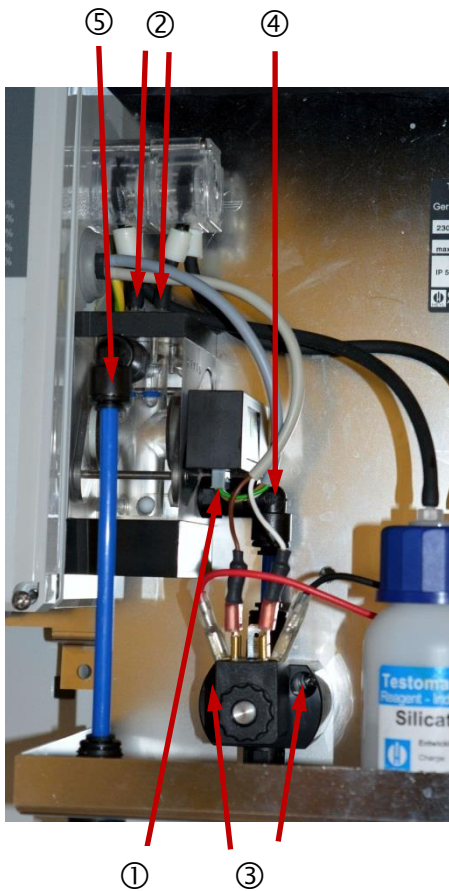

- Switch off the instrument.
- Close the stop valve in the branch line to Testomat® 808 SiO<sub>2</sub>.
- Prior to disassembling the measuring chamber, disconnect the cable ① from the LED holder and loosen the pump hoses at the hose connectors ② of the measuring chamber.
- You can also remove the reagent bottle to facilitate access.
- Loosen the two screws ③ fixing the solenoid valve to the rear panel. Press down the top locking ring of the solenoid valve to allow the valve to be pushed down onto the support.
- Turn the angled hose connector ④ upwards. Press the locking ring of the top angled hose connector ⑤ upwards and remove the outlet hose.
- Turn this angled hose connector ⑤ upwards to ensure that any residual water cannot escape from the measuring chamber. Now simply pull the measuring chamber off the retaining bolts towards the front.
- To drain the measuring chamber, turn the bottom angled hose connector ④ downwards and let the residual water drain off.

Disassemble the measuring chamber as follows for cleaning:

- Loosen the 4 screws (7) of the measuring chamber cover (4) and remove the cover and the flat seal (8).
- Remove the dosing needle (5) from the measuring chamber.
- Loosen 1 screw (6) on each side to remove the sight-glass window holders (2) at the sides of the measuring chamber.
- Remove the sight-glass windows (9) and the respective flat seals (8).
- Use isopropanol to clean the film off the sight-glass windows. If the instrument has been used to measure hard water for a longer period of time, a hard-to-remove film may have formed on the sight-glass windows. In this case, clean the sight-glass windows and the measuring chamber as described below.
- Clean the measuring chamber with a cleaning agent suitable for decalcification and rust removal (max. 5 – 10% solution). Flush the measuring chamber thoroughly after cleaning.
- Once the measuring chamber has been fully cleaned, it can be reinstalled. Reassemble in reverse order to disassembly.

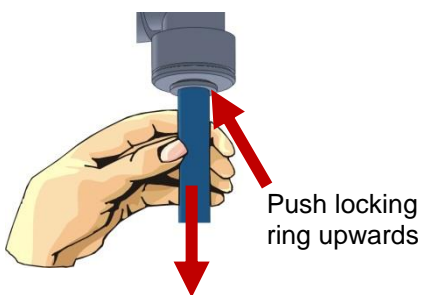

**ATTENTION****Removal and installation of the sight glass windows**

If the sight glass windows cannot be removed from the measurement chamber, open the measurement chamber cover (4) and then carefully push them out from the inside. Do not apply excessive force and do not use sharp objects that may damage the sight glass windows.

Ensure tension-free mounting of the sight glass windows. Tighten the screws (6) equally alternating both sides. Otherwise, the sight glass windows may break.

- Once all assembly work has been completed, bleed the lines before restarting the instrument (see the section entitled “[Inserting the reagent bottle](#)” on page 28).

- |    |                           |                             |
|----|---------------------------|-----------------------------|
| 1  | Measuring chamber         | (Article no 37533 (1-4bar)) |
| 2  | Sight-glass window holder | (Article no. 40176)         |
| 3  | Magnetic stirrer          | (Article no. 40050)         |
| 4  | Measuring chamber cover   | (Article no. 37679)         |
| 5  | Dosing needle             | (Article no. 37681)         |
| 6  | Screw M3x40               | (Article no. 33253)         |
| 7  | Screw M3x12               | (Article no. 33246)         |
| 8  | Flat seal 24x2            | (Article no. 33777)         |
| 9  | Sight-glass window 30x3   | (Article no. 40170)         |
| 10 | Hose connection           | (Article no. 37643)         |
| 11 | Angled plug in connector  | (Article no. 40157)         |
| 12 | O-ring 3.8x1.78           | (Article no. 33797)         |
| 13 | O-ring 4.5x1.5            | (Article no. 11264)         |
| 14 | O-ring 1.78x1.78          | (Article no. 11245)         |

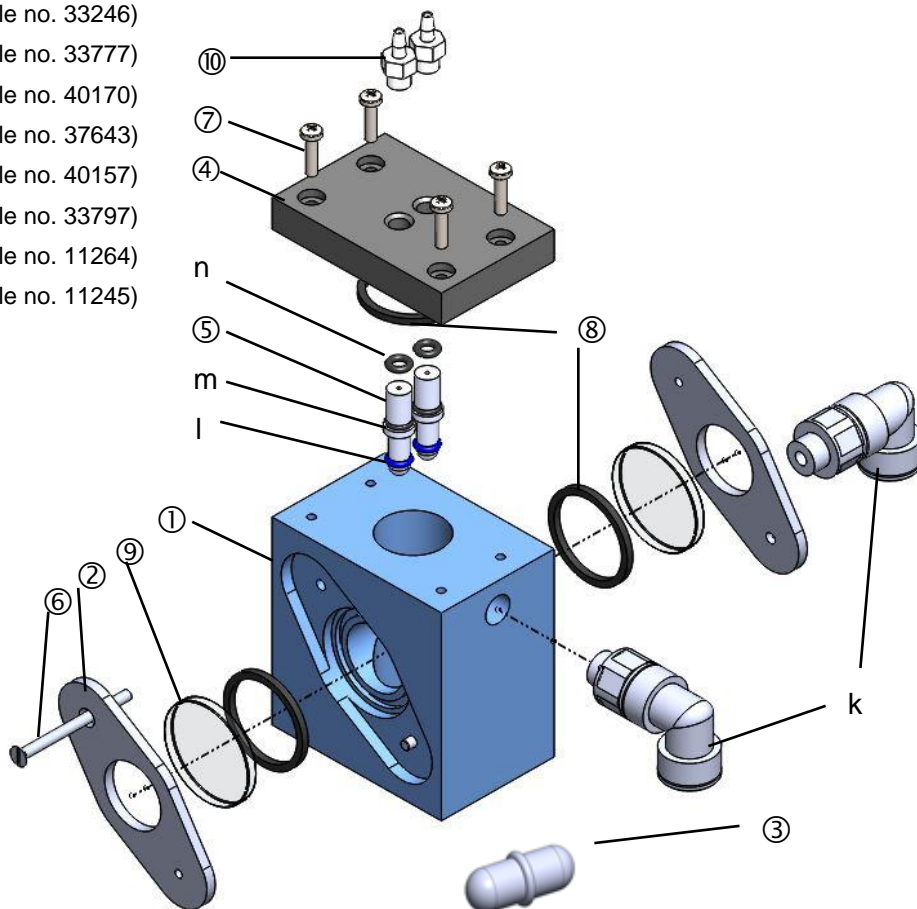

## Pump head maintenance message

The effective runtime of the pump head is counted during operation. After 150 hours of operation, the LED E4 flashes with the maintenance message for the pump head. This runtime for the pump will be reached during normal operation (analysis interval every 10 minutes) after approx. 2 years or 54000 analyses.

- Switch off the instrument to acknowledge the message.
- Press and hold key 4 (horn) when switching on the instrument. The operating time of the pump head is then reset to 0.

### NOTE

---

### Replacing the pump head

We recommend you to replace the pump head when the maintenance message for the pump head is displayed. Send the device in for maintenance. The pump heads must be replaced at the factory. In addition, a software update will be made.

---

### Motor block maintenance

We recommend that you also replace the motor block each time the pump head is replaced in order to prevent a failure.

Contact your service partner, who can carry out the replacement, or send in the device for maintenance.

## Testomat® 808 SiO2 2019 spare parts and accessories

### Caution!

Should you send your Testomat® 808 SiO2 2019 in for maintenance, please make sure that the measuring chamber has been emptied.

Art. no.	Spare parts – measuring chamber
33777	Flat seal 24x2
40170	PMMA sight-glass window 30x3
40176	Sight-glass window holder
33253	Screw M3x40, A2, DIN 965
33246	Screw M3x12
37533	Measuring chamber Testomat 808 SiO2, complete (1 – 4 bar)
37752	Measuring chamber Testomat 808 SiO2, complete (0.3 – 1 bar)
37679	Measuring chamber cover, SiO2
37681	Dosing needle, Testomat 808 SiO2
40050	Magnetic stirrer, processed
40157	Angled plug-in connector G1/8"-6
33797	O-ring 2.8x1.78
11264	O-ring 4.5x1.5
11245	O-ring 1.78x1.78
Art. no.	Spare parts - instrument
37321	Controller board Testomat 808, SMD
37923	Base circuit board Testomat 808 SiO2, cpl (230V)
37924	Base circuit board Testomat 808 SiO2, cpl (115V)
37925	Base circuit board Testomat 808 SiO2, cpl (24V)
40366	LED holder Testomat 808 SiO2*, complete
40394	Full set with optics board and LED holder*
37570	Solenoid valve Testomat 808
37859	Double pump head Testomat 808 SiO2
31592	Fuse, soldered T1.0A
31584	Fuse, soldered T0.2A
31595	Fuse, soldered T0.1A
31585	Fuse, soldered T0.315A
31666	Fuse GS-T, 5x20, T A4
37734	Cable ducting M16 x 1,5
37735	Nut for cable ducting M16 x 1,5
37736	Blanking plug for cable ducting

\* The full set of an optics board and LED holder is synchronised at the factory and can be used directly after installation. When replacing the optics board or LED holder individually, a synchronisation must be performed in the device, see "Maintenance and Service Instructions Testomat® 808 SiO2".

Art. no.	Bottle connection/Suction device
37579	Bottle insert for screw cap and push-fit suction tube, 500 ml bottle
37580	Bottle insert for screw cap and push-fit suction tube, 100 ml bottle
37643	Hose adapter
Art. no.	Accessories
37583	Candle filter Testomat 808 complete
37584	Filter insert
37593	Plug D = 6
37602	Pressure regulator, complete for Testomat
270343	Maintenance case Testomat 808 SiO2
270351	Service set Testomat 808
100494	Gear motor for dosing pump

### Accessories - reagents

Reagents	Art. no. 100 ml bottle	Art. no. 500 ml bottle
Testomat® 808 SiO2 reagent set, reagents A + B	140808	-
Testomat® 808 SiO2 reagent A	-	141808
Testomat® 808 SiO2 reagent B	-	141809

Please refer to our delivery programme for an up-to-date overview of available accessories at [www.heylanalysis.de](http://www.heylanalysis.de).

#### NOTE

#### Bottle connection

Testomat® 808 SiO2 is delivered with 2 bottle connections for a 500 ml bottle. Please order 2 bottle connections for a 100 ml bottle upon request.

## Technical data

Power supply:	(24 / 115)* 230V, 50 – 60 Hz  Instrument protection 230 – 240 V: T0.1 A Instrument protection: 115 V: T0.2 A Instrument protection: 24 V: T0.8 A	
Mains protection for consumers:	max. 4 A (N, L)	
Power consumption:	max. 16 VA, without external load	
Protection class:	I	
Degree of protection:	IP 44	
Conformity:	EN 61000-6-2, EN 61000-6-4, EN 61010-1 BS EN 61000-6-4+A1, BS EN 61000-6-2, BS EN 61010- 1+A1	
Ambient temperature:	15 - 25°C	
Measuring range:	See the section entitled "Performance specifications"	
Current interface:	Output of defined values (5, 8, 11, 14, 17, 20 mA) for displaying status and error messages, max. load 500 Ohms	
Contact load Relay	230V / 4A AC ohm resistive load	
Dimensions:	W x H x D = 364 x 314 x 138 mm With side pocket: 442 x 314 x 138 mm	
Weight:	4,350 g	
<b>Mains water supply</b>		
Operating pressure:	0.3 – 1 bar / 0,3 x 10 <sup>5</sup> to 1 x 10 <sup>5</sup> Pa (use measuring chamber with art. no. 37752!) 1 - 4 bar / 1 x 10 <sup>5</sup> to 4 x 10 <sup>5</sup> Pa depending on design (a pressure reducer (special accessories) should be used from 4 to 8 bar range)	
Water inlet:	Opaque hose with 6 mm external diameter/4 mm internal diameter	
Water outlet:	Hose with 6 mm external diameter/4 mm internal diameter	
Water temperature:	10 to 40°C	

**We reserve the right to make technical changes without notice in the interest of constantly improving our products!**



# Testomat® 808 SiO2 2019 checklist

Dear customers and service technicians,

This check list cannot replace your expertise or extensive experience in fault resolution. It is intended to support fast and systematic error diagnosis and error documentation. This list does not claim to be complete. We are therefore always grateful for any advice and information you may be able to provide. General user instructions can be found on the rear of this check list.

The Instrument Manufacturer

Block 1 / Plant and instrument data

		Instrument type	Instrument number	Indicator type	Software status

Block 2 / Error message and error history

Please mark appropriately (X)

What error messages does the instrument display? (Keys "3" (Standby) and "4" (horn)=> Operating instructions)			( LED )
Is the LED above key 4 flashing or lit?	Flashing	Lit	
Are other LEDs lit? Which ones?	Yes	No	( LED )

Block 3 / Visual inspection and functional test

Please mark appropriately (X)

If applicable, values / comments

Is the correct mains voltage (according to the rating plate) being supplied to the instrument?	Yes	No	
Does water flow out of the discharge hose during analysis?	Yes	No	
Are the measuring chamber and sight glasses clean?	Yes	No	
Are the measuring chamber and water hoses watertight?	Yes	No	
Do the reagents still have shelf life remaining? (See expiry date on the reagent bottle)	Yes	No	Expiry date:
Has the correct bottle size been set?	Yes	No	Size: 100 ml / 500 ml
Is the water pressure within the prescribed limits (400 ml/min)? (See the instrument's rating plate)	Yes	No	System pressure:
Has the outlet been installed free of back pressure along its total length? (No "siphon effect"!!)	Yes	No	
Is the outlet hose clear? (Contamination by micro organisms or similar)	Yes	No	
Has it been ensured that fresh measuring water reaches the measuring chamber within the flushing time of 10 seconds before the measurement is carried out?	Yes	No	
Are the dosing pump hoses free of air bubbles? (Operate the pump manually / carry out a manual analysis)	Yes	No	

**CARRYING OUT A MANUAL ANALYSIS**

Does the indicator pump supply a dose when an analysis is triggered?	Yes	No	
Is the indicator properly mixed in the water during the dosing process in the measuring chamber? Check the magnetic stirring bar!	Yes	No	

**PROGRAMMING DATA / OPERATING CONDITIONS**

Is the Testomat instrument constantly supplied with mains power - except during maintenance work/emergencies? (Occasional switching off only by means of the "Standby" or "Input stop" keys!)	Yes	No	See "General instructions for operating the Testomat® 808"
--	-----	----	--

Please refer to "Error messages / Troubleshooting" in the **operating instructions** for further information on error messages and possible causes of faults.

Further functional tests and service instructions can be found in the **maintenance manual**

If you have examined the instrument with the aid of the checklist and answered "Yes" to all questions in Block 3 it can be assumed that its functions are operating correctly.

We recommend that you carry out all tests contained in this checklist at every service and when faults have occurred.

## General user instructions for Testomat® 808 SiO<sub>2</sub>

### Basic design of the instrument

As a monitoring instrument, the Testomat® 808 SiO<sub>2</sub> has been designed for permanently monitoring water by means of daily measurements. Several measurements per day are assumed under standard conditions of use. Should the instruments be operated with longer periods between analyses (interval times), attention must be paid to appropriate flushing times and flushing water volumes respectively. In case of non-compliance residual or mixed water from the hoses may be measured, leading to thresholds being exceeded. The indicator expiry date can also be exceeded under certain circumstances.

Long interval times often make little sense. It may be that avoidable problems arise instead of achieving desired savings. The water requirement per analysis also amounts to only 80 to 150 ml.

### Switching off the instruments / Stopping the measurements

Interruptions to measurements should only be made using the functions, "Standby" (at the instrument) and "Stop" (external) provided for this purpose. Switching the instruments off by **disconnecting them from the mains does not make sense** because

- when disconnected from the mains, the instruments can stop with their measuring chambers full of water resulting in heavy soiling of measuring chamber, sight glasses and stirring rod

In this case, malfunctions due to an improper restart and unclear error messages cannot be excluded. However, if instruments are switched off for several days, care should be taken to ensure that measuring chambers are only filled with water and the restart is carried out in the same way as a first commissioning. At least the dosing pump should be operated manually until the hose is emptied of air.

### Initial start-up of new plants

For new plants we recommend **flushing the pipelines** thoroughly before connecting the instrument. We recommend fitting a fine filter to the water supply hose - see our range of products. This filter should be cleaned or replaced at regular intervals because solid particles can clog the filter when operated for longer periods. If this is not noticed, malfunctions and error messages caused by the reduced flow of water cannot be excluded. In case of a correspondingly high concentration, particles can reach the solenoid valve despite the presence of a filter. This could compromise its function.

### Operation/Reagents

The proper operation of Testomat instruments can only be assured **where original Heyl Testomat® reagents are used**. These reagents permit an exact analytic measurement of the smallest quantities of substances. As for all reactive chemical substances, their effectiveness is also influenced by environmental conditions (15 – 25°C). The shelf life data which we have calculated are based on use and storage at room temperature and the exclusion of direct light. Deviating influencing factors and environmental parameters or those not tested by us can result in a variation in the shelf life threshold.

The reagents must be replaced upon the expiry of its shelf life in order to guarantee its reliable function. Please note the expiry date on the bottle's label.

### Water inlet

Compliance with the water inlet pressure limits recorded on the rating plate is essential. Should the water flow be insufficient, (e.g. also in case the filter is soiled) there is no proper exchange of measuring water and therefore a clear analysis cannot be assured.

The measuring process can be repeated several times and ultimately result in error messages.

### Water outlet

In assembly, care should be taken to ensure a **discharge free of back pressure** as described in the operating instructions, "Water outlet".

## EC conformity Declaration



EC Conformity Declaration



**for the following product**

**Testomat® 808 SiO<sub>2</sub>**  
**Online Analysis Instrument for silica up to 1.2 mg/l**

We hereby confirm that the above product conforms to the principal health and safety regulations laid down in the EC Directives 2014/30/EU and 2014/35/EU.

This declaration applies to all units produced in accordance with the attached manufacturing documents which are a constituent part of this declaration.

**The product was assessed with reference to the following standards:**



**EN 61000-6-4:** Electromagnetic compatibility, Generic emission standard

**EN 61000-6-2:** Electromagnetic compatibility, Generic immunity standard

**EN 61010-1:** Safety requirements for electrical equipment for measurement, control and laboratory use



**BS EN 61000-6-4+A1** Electromagnetic compatibility (EMC). Generic standards. Emission standard for industrial environments

**BS EN 61000-6-2** Electromagnetic compatibility (EMC). Generic standards. Immunity standard for industrial environments

**BS EN 61010-1+A1** Safety requirements for electrical equipment for measurement, control, and laboratory use. General requirements

This declaration is made on behalf of

**GEBRÜDER HEYL**  
**Analysentechnik GmbH & Co. KG**  
**Orleansstraße 75b**  
**31135 Hildesheim**

by

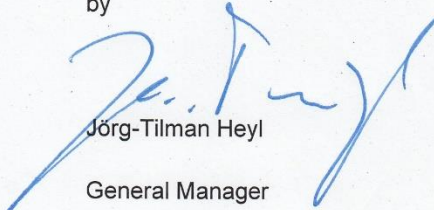
  
Jörg-Tilman Heyl  
General Manager

Hildesheim, 12/08/2021

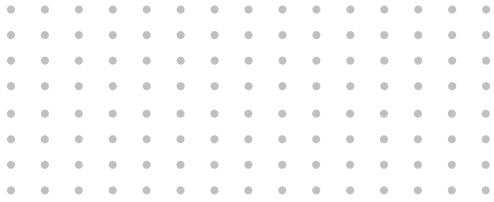

Gebrüder Heyl  
Analysentechnik GmbH & Co. KG  
Orleansstraße 75b  
D 31135 Hildesheim  
[www.heylandanalysis.de](http://www.heylandanalysis.de)

Testomat\_808-2019\_Si\_EN\_230628



Scan the code and  
visit us on our website!